

## Dual 1 Form A Solid State Relay

### Features

- Dual Channel (LH1546)
- Current Limit Protection
- Isolation Test Voltage 5300 V<sub>RMS</sub>
- Typical R<sub>ON</sub> 28 Ω
- Load Voltage 350 V
- Load Current 120 mA
- High Surge Capability
- Clean Bounce Free Switching
- Low Power Consumption
- SMD Lead Available on Tape and Reel
- Lead-free component
- Component in accordance to RoHS 2002/95/EC and WEEE 2002/96/EC

### Agency Approvals

- UL1577, File No. E52744 System Code H or J, Double Protection
- CSA - Certification 093751
- BSI/BABT Cert. No. 7980
- DIN EN 60747-5-2 (VDE0884)  
DIN EN 60747-5-5 pending
- FIMKO Approval

### Applications

General Telecom Switching

- On/off Hook Control
- Ring Relay
- Dial Pulse
- Ground Start
- Ground Fault Protection

Instrumentation

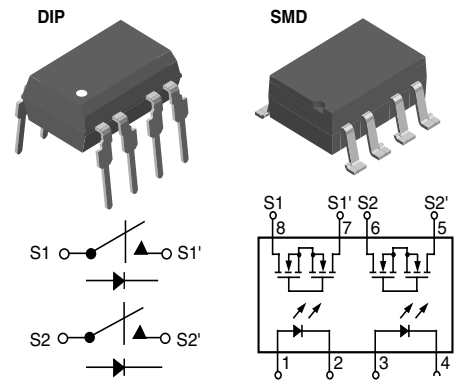

1179034



Industrial Controls

### Description

The LH1556 dual 1 Form A relays are SPST normally open switches that can replace electromechanical relays in many applications. They are constructed using a GaAlAs LED for actuation control and an integrated monolithic die for the switch output. The die, fabricated in a high-voltage dielectrically isolated technology is comprised of a photodiode array, switch control circuitry, and MOSFET switches. In addition, the LH1556 SSRs employ current-limiting circuitry, enabling them to pass FCC 68.302 and other regulatory surge requirements when overvoltage protection is provided.

### Order Information

Part	Remarks
LH1556AB	Tubes, DIP-8
LH1556AAC	Tubes, SMD-8
LH1556AACTR	Tape and Reel, SMD-8

### Absolute Maximum Ratings, $T_{amb} = 25\text{ }^{\circ}\text{C}$

Stresses in excess of the absolute Maximum Ratings can cause permanent damage to the device. Functional operation of the device is not implied at these or any other conditions in excess of those given in the operational sections of this document. Exposure to absolute Maximum Ratings for extended periods of time can adversely affect reliability.

### SSR

Parameter	Test condition	Symbol	Value	Unit
LED continuous forward current		$I_F$	50	mA
LED reverse voltage	$I_R \leq 10\text{ }\mu\text{A}$	$V_R$	8.0	V
DC or peak AC load voltage	$I_L \leq 50\text{ }\mu\text{A}$	$V_L$	350	V
Continuous DC load current - one pole operating		$I_L$	120	mA
Continuous DC load current - two pole operating		$I_L$	250	mA
Peak load current (single shot)	$t = 100\text{ ms}$	$I_P$	1)	mA
Ambient temperature range		$T_{amb}$	- 40 to + 85	$^{\circ}\text{C}$
Storage temperature range		$T_{stg}$	- 40 to + 150	$^{\circ}\text{C}$
Pin soldering temperature	$t = 10\text{ s max}$	$T_s$	260	$^{\circ}\text{C}$
Input/output isolation voltage		$V_{ISO}$	5300	$V_{RMS}$
Output power dissipation (continuous)		$P_{diss}$	550	mW

1) Refer to Current Limit Performance Application Note for a discussion on relay operation during transient currents.

### Electrical Characteristics, $T_{amb} = 25\text{ }^{\circ}\text{C}$

Minimum and maximum values are testing requirements. Typical values are characteristics of the device and are the result of engineering evaluations. Typical values are for information only and are not part of the testing requirements.

### Input

Parameter	Test condition	Symbol	Min	Typ.	Max	Unit
LED forward current, switch turn-on	$I_L = 100\text{ mA}$ , $t = 10\text{ ms}$	$I_{Fon}$		1.1	2.0	mA
LED forward current, switch turn-off	$V_L = \pm 350\text{ V}$	$I_{Foff}$	0.2	1.0		mA
LED forward voltage	$I_F = 10\text{ mA}$	$V_F$	1.15	1.26	1.45	V

### Output

Parameter	Test condition	Symbol	Min	Typ.	Max	Unit
ON-resistance ac/dc: Pin 4 ( $\pm$ ) to 6 ( $\pm$ )	$I_F = 5.0\text{ mA}$ , $I_L = 50\text{ mA}$	$R_{ON}$		28	35	$\Omega$
ON-resistance dc: Pin 4, 6 (+) to 5 (-)	$I_F = 5.0\text{ mA}$ , $I_L = 100\text{ mA}$	$R_{ON}$		7.0	10.0	$\Omega$
Off-resistance	$I_F = 0\text{ mA}$ , $V_L = \pm 100\text{ V}$	$R_{OFF}$	0.5	300		$G\Omega$
Current limit ac/dc	$I_F = 5.0\text{ mA}$ , $V_L = \pm 6.0\text{ V}$ , $t = 5.0\text{ ms}$	$I_{LMT}$	170	210	250	mA
Off-state leakage current	$I_F = 0\text{ mA}$ , $V_L = \pm 100\text{ V}$	$I_O$		0.35	200	nA
	$I_F = 0\text{ mA}$ , $V_L = \pm 350\text{ V}$	$I_O$		0.096	1.0	$\mu\text{A}$
Output capacitance Pin 4 to 6	$I_F = 0\text{ mA}$ , $V_L = 1.0\text{ V}$	$C_O$		18		pF
	$I_F = 0\text{ mA}$ , $V_L = 50\text{ V}$	$C_O$		6.7		pF
Switch offset	$I_F = 5.0\text{ mA}$	$V_{OS}$		0.3		$\mu\text{V}$

## Transfer

Parameter	Test condition	Symbol	Min	Typ.	Max	Unit
Capacitance (input-output)	$V_{ISO} = 1.0\text{ V}$	$C_{IO}$		0.67		pF
Turn-on time	$I_F = 5.0\text{ mA}$ , $I_L = 50\text{ mA}$	$t_{on}$		1.14	3.0	ms
Turn-off time	$I_F = 5.0\text{ mA}$ , $I_L = 50\text{ mA}$	$t_{off}$		0.71	3.0	ms

## Typical Characteristics ( $T_{amb} = 25\text{ }^\circ\text{C}$ unless otherwise specified)

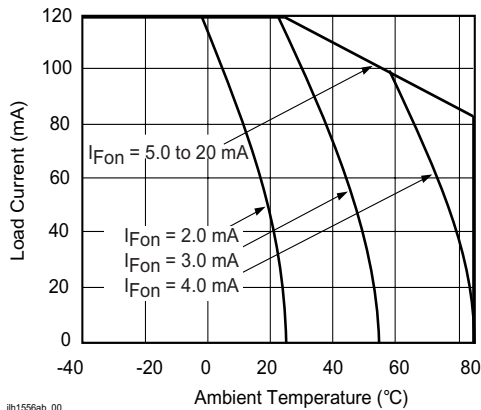

Figure 1. Recommended Operating Conditions

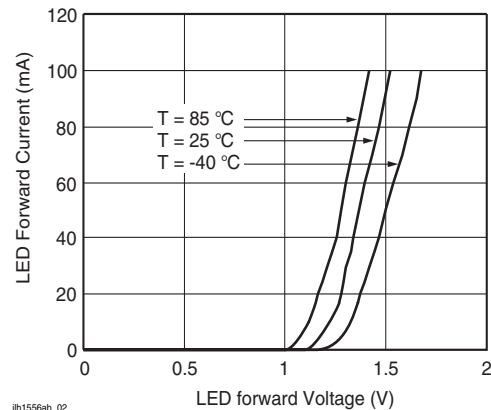

Figure 3. LED Forward Current vs. LED Forward Voltage

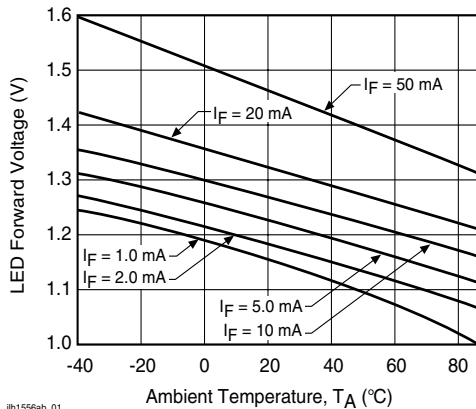

Figure 2. LED Voltage vs. Temperature

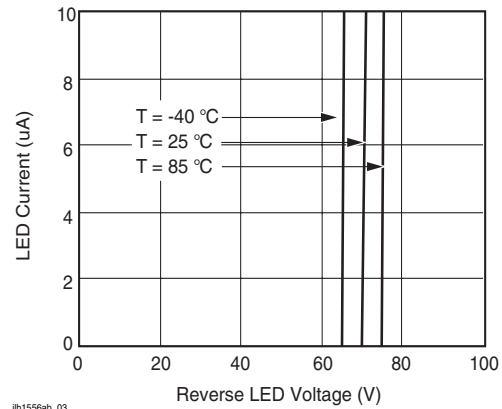
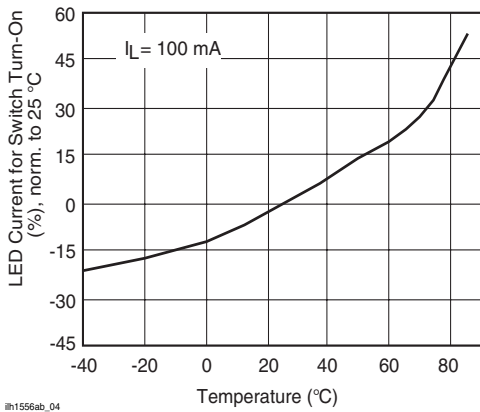
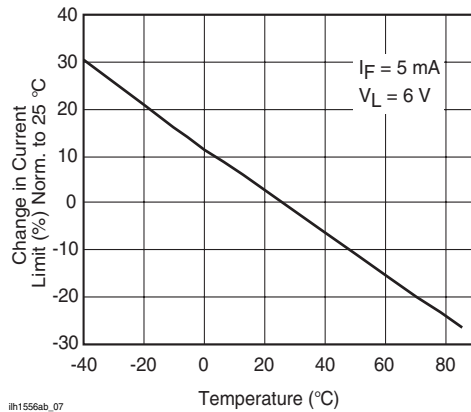

Figure 4. LED Reverse Current vs. LED Reverse Voltage



ih1556ab\_04

Figure 5. LED Current for Switch Turn-on vs. Temperature



ih1556ab\_07

Figure 8. Current Limit vs. Temperature

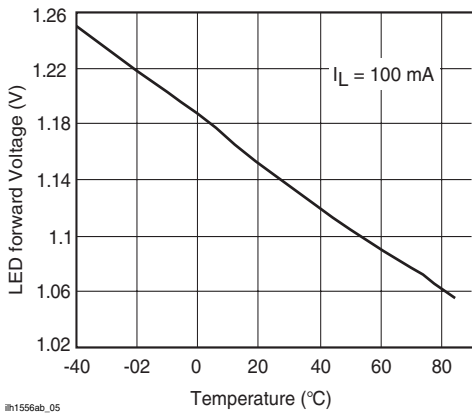

ih1556ab\_05

Figure 6. LED Dropout Voltage vs. Temperature

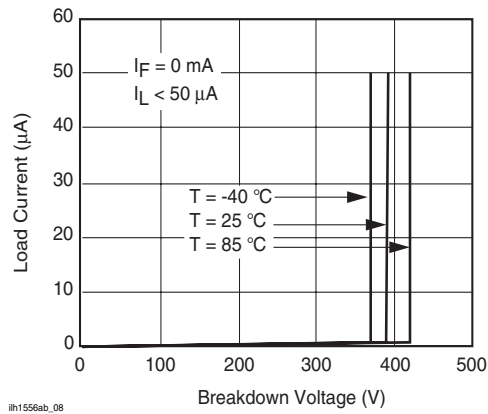

ih1556ab\_08

Figure 9. Switch Breakdown Voltage vs. Load Current

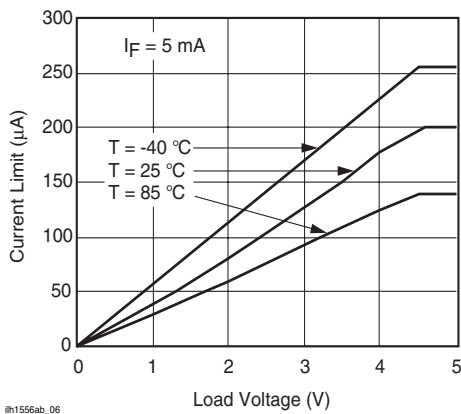

ih1556ab\_06

Figure 7. Load Current vs. Load Voltage

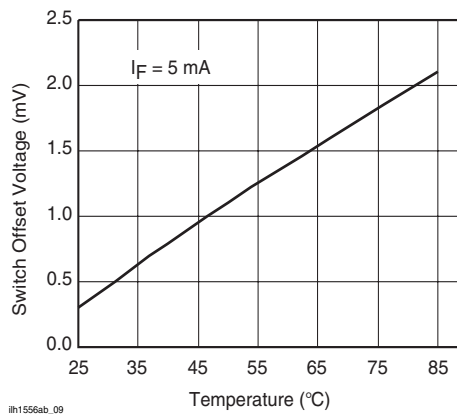

ih1556ab\_09

Figure 10. Switch Offset Voltage vs. LED Current

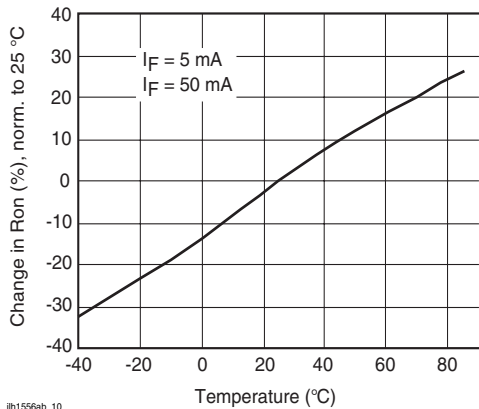

ih1556ab\_10

Figure 11. ON-Resistance vs. Temperature

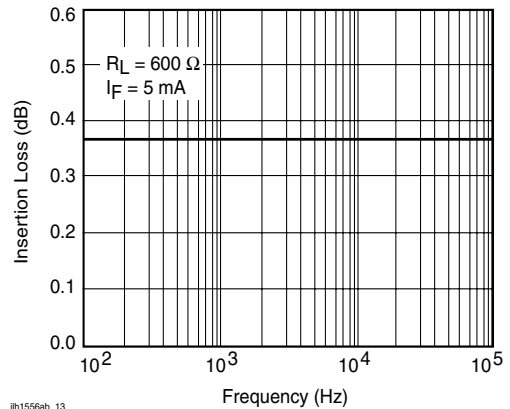

ih1556ab\_13

Figure 14. Insertion Loss vs. Frequency

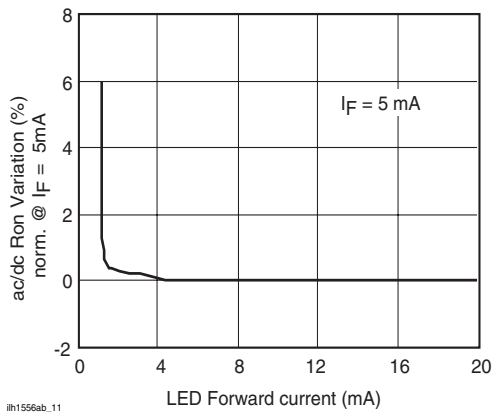

ih1556ab\_11

Figure 12. Variation in ON-Resistance vs. LED Current

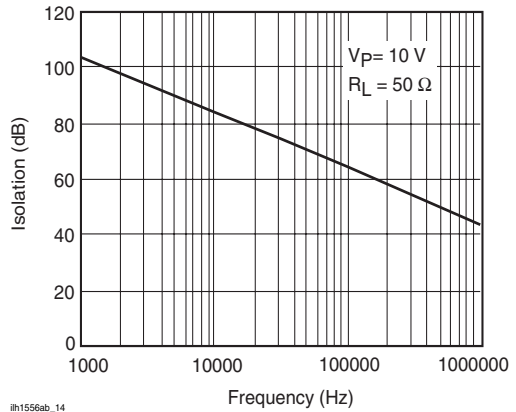

ih1556ab\_14

Figure 15. Output Isolation

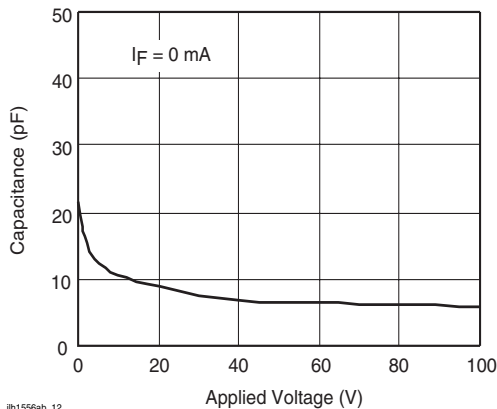

ih1556ab\_12

Figure 13. Switch Capacitance vs. Applied Voltage

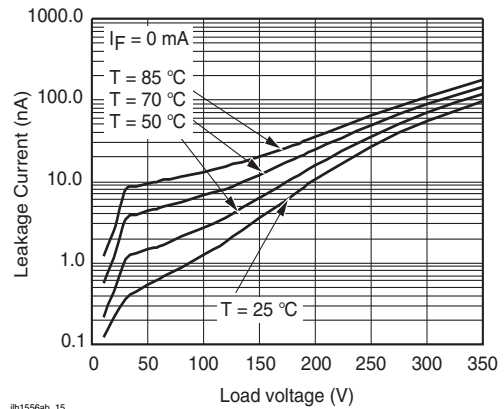

ih1556ab\_15

Figure 16. Leakage Current vs. Applied Voltage at Elevated Temperatures

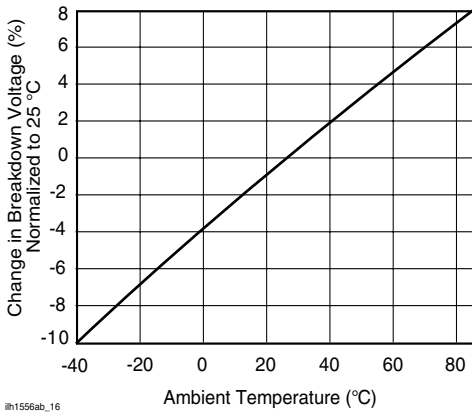

ih1556ab\_16

Figure 17. Switch Breakdown Voltage vs. Temperature

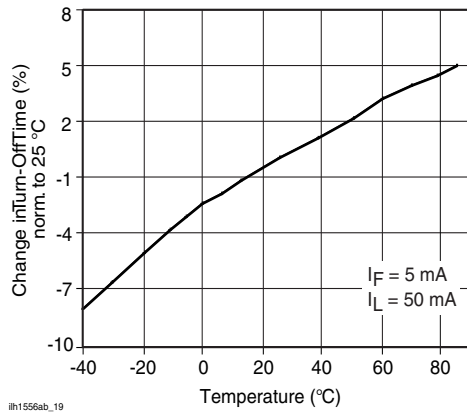

ih1556ab\_19

Figure 20. Turn-off Time vs. Temperature

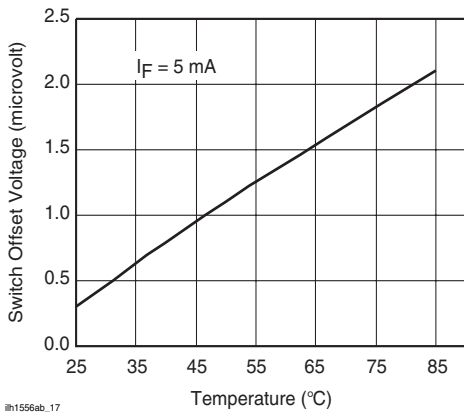

ih1556ab\_17

Figure 18. Switch Offset Voltage vs. Temperature

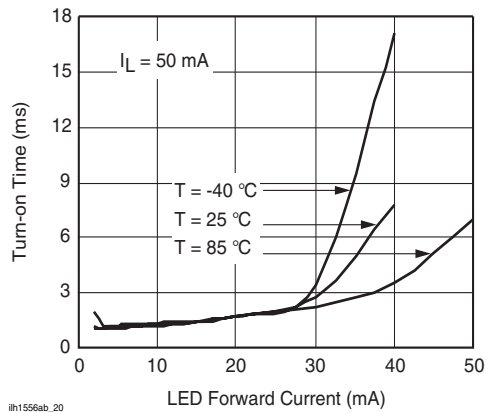

ih1556ab\_20

Figure 21. Turn-on Time vs. LED Current

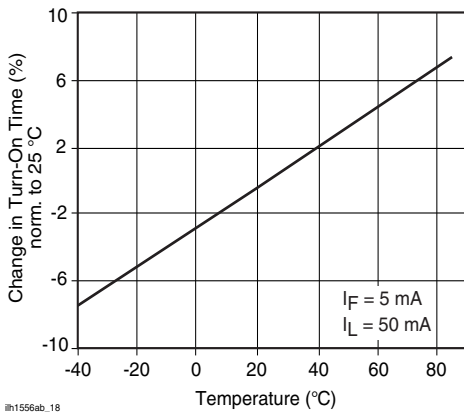

ih1556ab\_18

Figure 19. Turn-on Time vs. Temperature

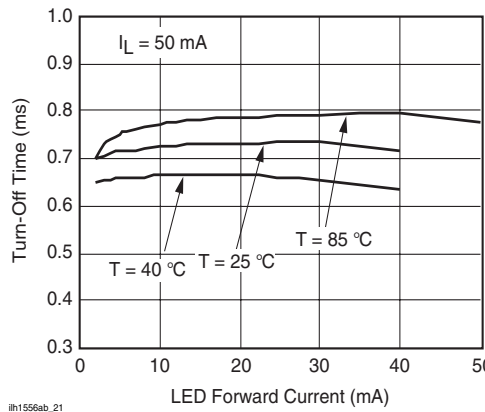

ih1556ab\_21

Figure 22. Turn-off Time vs. LED Current

## Package Dimensions in Inches (mm)

### DIP

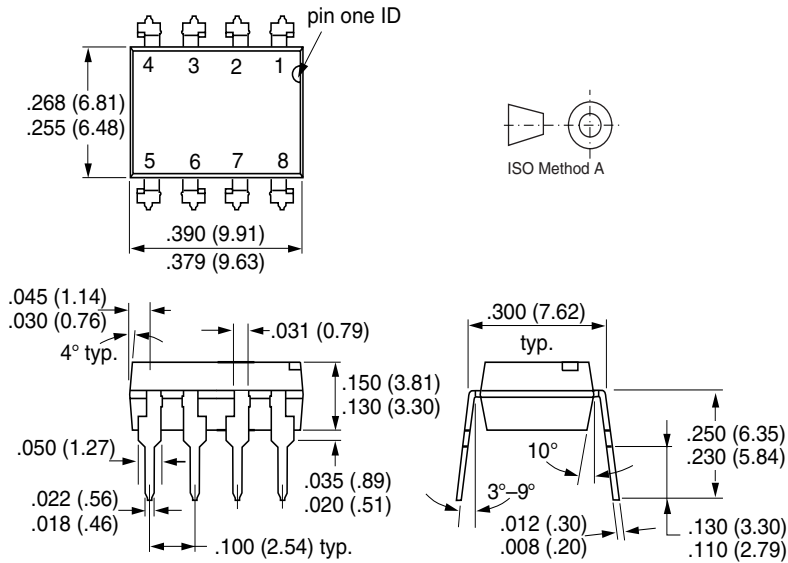

i178008

## Package Dimensions in Inches (mm)

### SMD

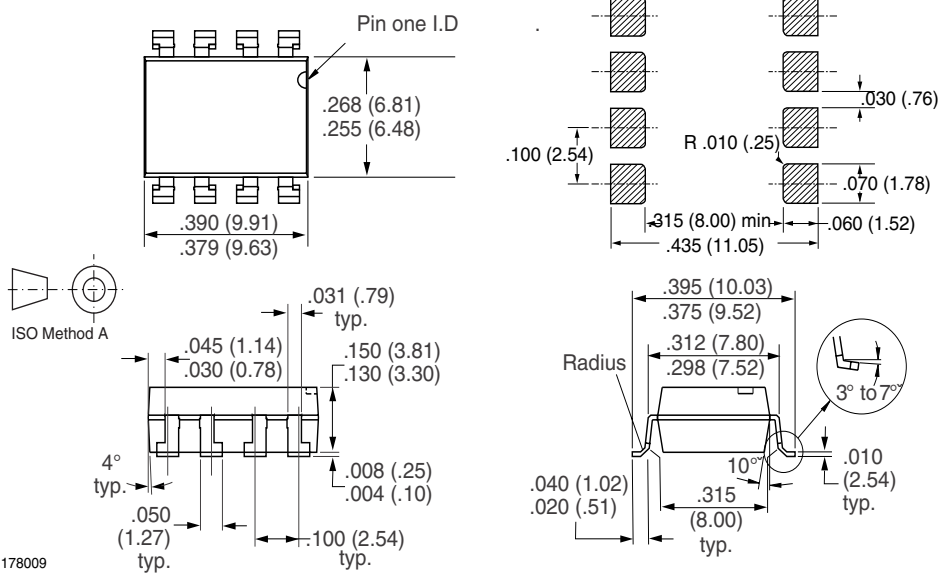

i178009

### Ozone Depleting Substances Policy Statement

It is the policy of Vishay Semiconductor GmbH to

1. Meet all present and future national and international statutory requirements.
2. Regularly and continuously improve the performance of our products, processes, distribution and operating systems with respect to their impact on the health and safety of our employees and the public, as well as their impact on the environment.

It is particular concern to control or eliminate releases of those substances into the atmosphere which are known as ozone depleting substances (ODSs).

The Montreal Protocol (1987) and its London Amendments (1990) intend to severely restrict the use of ODSs and forbid their use within the next ten years. Various national and international initiatives are pressing for an earlier ban on these substances.

Vishay Semiconductor GmbH has been able to use its policy of continuous improvements to eliminate the use of ODSs listed in the following documents.

1. Annex A, B and list of transitional substances of the Montreal Protocol and the London Amendments respectively
2. Class I and II ozone depleting substances in the Clean Air Act Amendments of 1990 by the Environmental Protection Agency (EPA) in the USA
3. Council Decision 88/540/EEC and 91/690/EEC Annex A, B and C (transitional substances) respectively.

Vishay Semiconductor GmbH can certify that our semiconductors are not manufactured with ozone depleting substances and do not contain such substances.

We reserve the right to make changes to improve technical design  
and may do so without further notice.

Parameters can vary in different applications. All operating parameters must be validated for each customer application by the customer. Should the buyer use Vishay Semiconductors products for any unintended or unauthorized application, the buyer shall indemnify Vishay Semiconductors against all claims, costs, damages, and expenses, arising out of, directly or indirectly, any claim of personal damage, injury or death associated with such unintended or unauthorized use.

Vishay Semiconductor GmbH, P.O.B. 3535, D-74025 Heilbronn, Germany  
Telephone: 49 (0)7131 67 2831, Fax number: 49 (0)7131 67 2423





## Disclaimer

All product specifications and data are subject to change without notice.

Vishay Intertechnology, Inc., its affiliates, agents, and employees, and all persons acting on its or their behalf (collectively, "Vishay"), disclaim any and all liability for any errors, inaccuracies or incompleteness contained herein or in any other disclosure relating to any product.

Vishay disclaims any and all liability arising out of the use or application of any product described herein or of any information provided herein to the maximum extent permitted by law. The product specifications do not expand or otherwise modify Vishay's terms and conditions of purchase, including but not limited to the warranty expressed therein, which apply to these products.

No license, express or implied, by estoppel or otherwise, to any intellectual property rights is granted by this document or by any conduct of Vishay.

The products shown herein are not designed for use in medical, life-saving, or life-sustaining applications unless otherwise expressly indicated. Customers using or selling Vishay products not expressly indicated for use in such applications do so entirely at their own risk and agree to fully indemnify Vishay for any damages arising or resulting from such use or sale. Please contact authorized Vishay personnel to obtain written terms and conditions regarding products designed for such applications.

Product names and markings noted herein may be trademarks of their respective owners.